

# **Robust. Reliable. Ready-to-use.**

Femtosecond fiber lasers



# Precision in photonics

Together we shape a sustainable future.

As the world's first commercial supplier of optical frequency combs, Menlo Systems has been leveraging innovation in laser technology for over 20 years. As a result, today we offer a portfolio of femtosecond fiber lasers based on our proprietary figure 9<sup>®</sup> mode locking technology<sup>1,2</sup> - uniting scientific precision with industrial robustness.

At the core of figure 9<sup>®</sup> is an all polarization-maintaining fiber design, efficiently decoupling the laser cavity from perturbations such as vibrations and temperature fluctuations.

The technology contains no critical or lifetime limiting components, such as degradable optics. Whether designed to serve science or industry, our femtosecond fiber lasers exhibit exceptional performance:

- **Robust.** A single well-defined mode-locked state guarantees robust self-start and mode-locked operation within seconds – even in the harshest environments.
- **Reliable.** Reproducible laser performance you can rely on, even after thousands of on/off cycles, with excellent power stability, pulse-to-pulse repeatability, and unsurpassed low-noise performance.
- **Ready-to-use.** After installation, our lasers are maintenance free, thermally managed without any external cooling, and turn-key operated.



Dr. Michael Mei (left) and Dr. Ronald Holzwarth (right)  
Managing directors and co-founders of Menlo Systems



Nobel Prize Laureate Prof. Theodor Hänsch  
Pioneer of optical frequency comb technology  
Co-founder of Menlo Systems

<sup>1</sup> Patents EP 2637265 A1 / CN 103311780 A / US 8873601 B2

<sup>2</sup> W. Hänsel et. al., Appl. Phys. B (2017) 123:41

# Robust. Reliable. Ready-to-use.

Femtosecond fiber lasers: Serving science and industry



## Ready for integration INDUSTRIAL SERIES

- Ultra-compact designs with factory-set repetition rates
- Excellent cost-performance ratio and low cost of ownership through use of standard telecom components and Telcordia-qualified pump diodes – all ready for 24/7 operation
- Fast and easy OEM integration via a modular concept and fiber-coupled interconnects
- Quickly adaptable options like dispersion pre-compensation, multiple amplifier seeding, pulse picking, and fast amplitude modulation

## Ready for synchronization SCIENTIFIC SERIES

- Optional intracavity actuators for repetition rate tuning, synchronization, and carrier envelope phase (CEP) stabilization at exceptionally low intrinsic phase noise
- Complete synchronization solutions with timing jitter on the attosecond level
- Asynchronous Optical Sampling (ASOPS), also with multi-color lasers
- Optional frequency conversion and supercontinuum generation modules

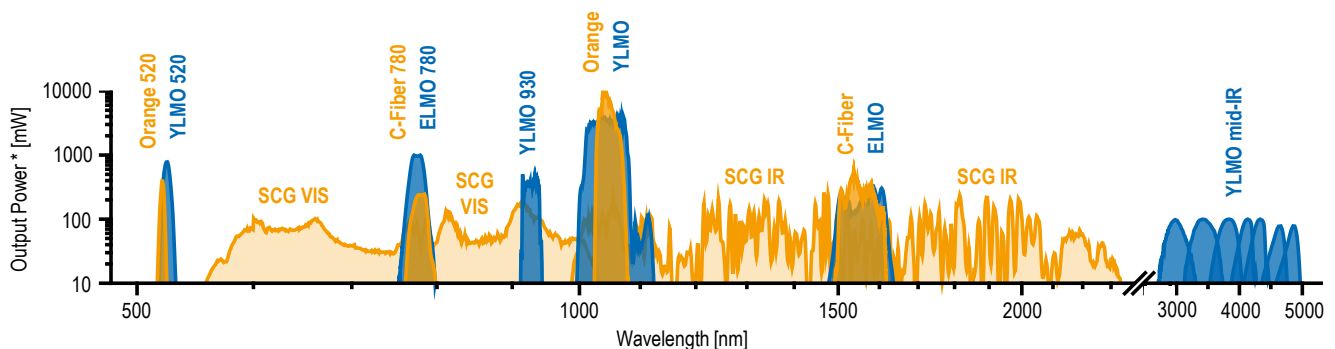

\* Optical spectra scaled to maximum average power

# Application spotlights

From cutting-edge research to industrial innovation

Courtesy Vanguard Automation

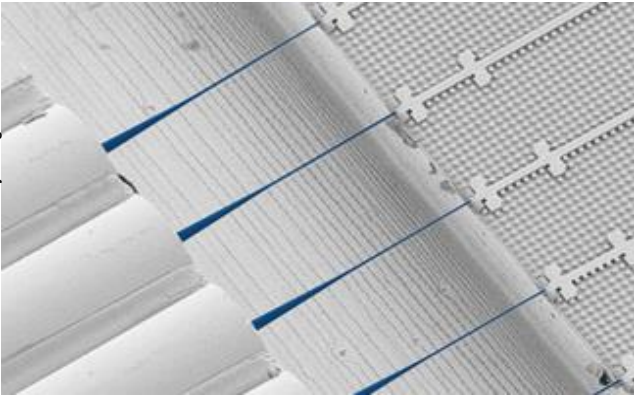

3D nanoprinted structures (in blue) - so-called Photonic Wire Bonds - guiding light in photonic integrated circuits. They provide high coupling efficiencies using tapered structures for mode-matching. Employed laser: **Industrial Series**.

## 3D nanoprinting

The nanoscale variant of additive manufacturing employs femtosecond laser pulses to engineer almost arbitrary 3D structures via multi-photon absorption in photosensitive materials.

Menlo Systems' femtosecond fiber lasers lead with excellent beam quality and pointing stability, integrated modulation and pulse pre-compression options, and pulse-to-pulse repeatability and reliability.

Courtesy das-Nano



Optical fibers inside the supply hose of a robotic arm supplying femtosecond laser pulses for THz-based paint layer thickness measurements. Approximately 30,000 car bodies per year can be inspected. Employed laser: **ELMO Series**.

## Terahertz generation

Electromagnetic radiation in the range of several hundreds of micrometers opens new horizons in fields spanning material sciences, quality control, and non-destructive testing.

Menlo Systems has a proven track record of serving leading OEM integrators with customized, industry-grade laser system designs, and continues to leverage this experience by developing turn-key THz solutions in-house.

Courtesy Laboratory of Attosecond Physics



Inspection of a Watt-level ultrafast mid-infrared source, seeded by a frequency-shifted Erbium-based femtosecond fiber laser. The spectral coverage extends over the molecular fingerprint region. Employed seed laser: **C-Fiber Series**.

## Amplifier seeding

The generation of ultra-intense laser pulses not only pushes boundaries in fundamental physics, but also increasingly finds its way into industrial applications, like material processing.

Our femtosecond fiber laser portfolio aligns to ever-demanding seed laser requirements - with customizable repetition rates, spectral bandwidths and pulse durations, as well as a wide range of options for synchronization and carrier-envelope-phase (CEP) stabilization.

# Application spotlights

From cutting-edge research to industrial innovation

## Microscopy and life sciences

Continuously refined multiphoton imaging methodologies provide impressive insight into complex and dynamic biological processes, with ever-increasing resolution and tissue penetration depths.

Our truly worry-free laser light sources provide users with the peace of mind to focus on their imaging applications. Installation is as easy as it gets: It takes just a few minutes to operate our compact and maintenance-free lasers at the push of a button.

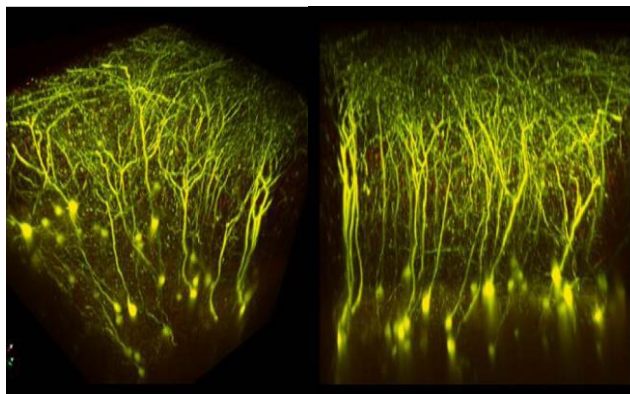

Two-Photon microscopy images of a YFP-labeled mouse brain, captured by a Thorlabs Cerna microscope. Employed laser: **YLMO Series**.

## Ultrafast spectroscopy

Sequences of ultrashort pulses examine dynamics of charge carriers, atoms, or inter- and intra-molecular processes with unprecedented time-resolution.

We continue to enhance the experimentalist's toolbox by steadily expanding the wavelength coverage of our femtosecond fiber laser portfolio – along with customizations like multi-color outputs, supercontinuum generation, or turn-key synchronization solutions.

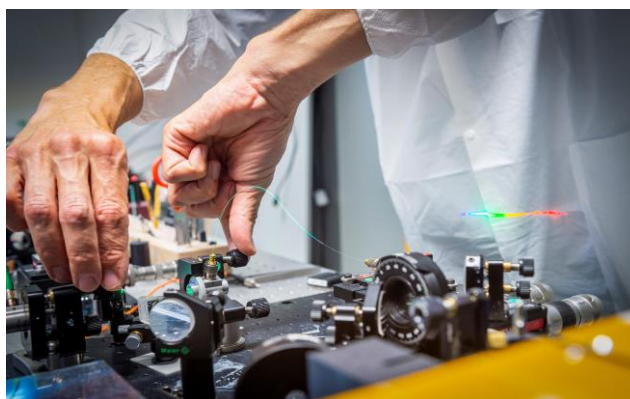

Supercontinuum generation (SCG) undergoing tests in an in-house R&D set-up. Employed laser: **Orange Series**.

## Ready to fly

Over the years, Menlo Systems' femtosecond fiber lasers were released in drop towers, used in airborne missions, tested in parabolic flights, and have travelled on suborbital rocket missions. Now, an ongoing research project will result in a figure 9® mode-locked frequency comb installed on the International Space Station.

Whatever the application, our technology can fly – almost everywhere.



The world's first airborne frequency comb on a mission to enable a LIDAR-based greenhouse gas monitoring campaign – employing figure 9® technology.

# ELMO

Delivering 24/7 across all industries

## KEY FEATURES

- Output power > 330 mW at 1560 nm
- Pulse width < 60 fs
- Repetition rate customizable in the range 50-100 MHz
- Extremely robust, all-fiber design
- Ultra-compact
- Fast and easy integration via its modular concept



Here comes a true workhorse: ELMO is a robust and cost-effective solution engineered for 24/7 operation - ultra-compact and ready for OEM integration. With an all-fiber design and without any moving parts, it delivers dependable operation even in the harshest environments, with excellent pulse-to-pulse reliability and power stability.

The ELMO series is a highly-flexible design concept, based on fiber-coupled oscillator (ELMO), fiber-coupled amplifier (ELMO HP), and free-space output compressor (ELMO HP-FS) modules. Fiber-based interconnects between different modules enable fast and easy adaptation to applications requiring multiple output ports, or seeding of multiple amplifiers.

## PERFORMANCE DATA

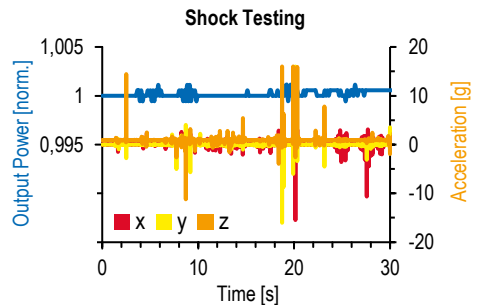
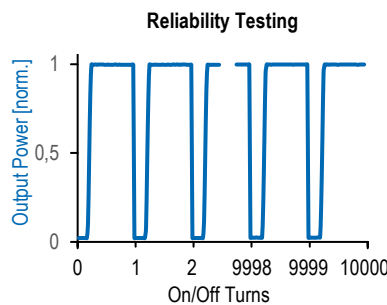
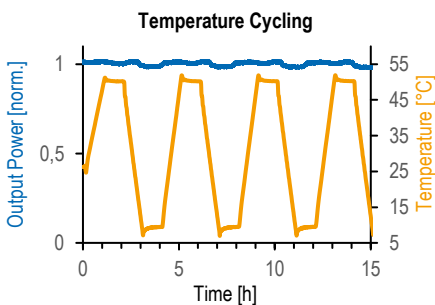
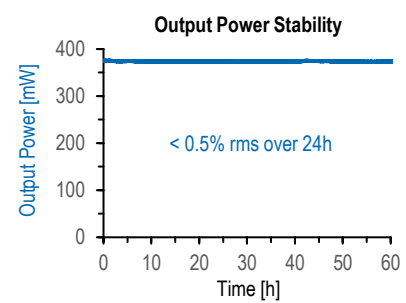
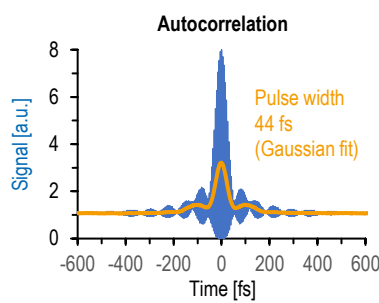
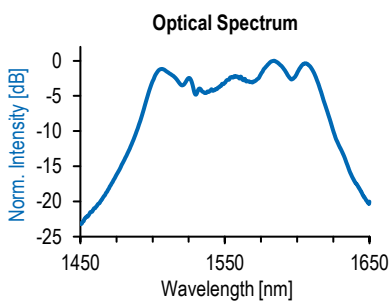

## SPECIFICATIONS

Model	ELMO	ELMO HP	ELMO HIGH HP-FS
Contained Modules *	oscillator	oscillator, amplifier	oscillator, amplifier, free-space compressor

## OUTPUT CHARACTERISTICS

Center Wavelength	1560 nm +/- 30 nm		
Average Power	> 10 mW	> 180 mW	> 330 mW
Pulse Width	< 150 fs (typ. 100 fs)	< 60 fs (typ. 45 fs)	< 90 fs (typ. 70 fs)
Repetition Rate	100 MHz		
Output Port	fiber-coupled (PM fiber, FC/APC connector)		free-space
Output Fiber Length	0.5 m		n.a.
Polarization	linear		linear, p-polarized **

## OPTIONS \*\*\*

Output Fiber Length	0.5-50 m	n.a.
Repetition Rate	factory-set value in the range 50-100 MHz	
Pulse Picking	down to kHz range	
Multiple Output Ports	please inquire for additional oscillator/amplifier output ports	
Supercontinuum Extension	please inquire	NIR [1050 - 2100 nm]

## REQUIREMENTS

Warm-Up Time	< 60 s		
Operating Temperature	15 °C - 35 °C		
Operating Voltage	12 VDC (external power supply for 100/115/230 VAC included)		
Power Consumption	10 W	20 W	
Communication Options	software/USB, CAN-BUS, handheld remote unit		

## DIMENSIONS

Laser Head Dimensions / Weight	195 x 95 x 28 mm <sup>3</sup> / 0.7 kg	195 x 95 x 75 mm <sup>3</sup> / 2.5 kg	195 x 95 x 75 mm <sup>3</sup> / 2.5 kg
Compressor Dimensions / Weight	n.a.	n.a.	182 x 95 x 32 mm <sup>3</sup> / 1.0 kg

\* Fiber-based interconnects between all modules, standard patch cord length: 0.5 m

\*\* In standard mounting configuration, free-space compressor module can be mounted in arbitrary orientation

\*\*\* Please inquire for specific combinations of output fiber length, pulse width, repetition rate, average power, and number of oscillator/amplifier module output ports

## TECHNICAL DRAWINGS

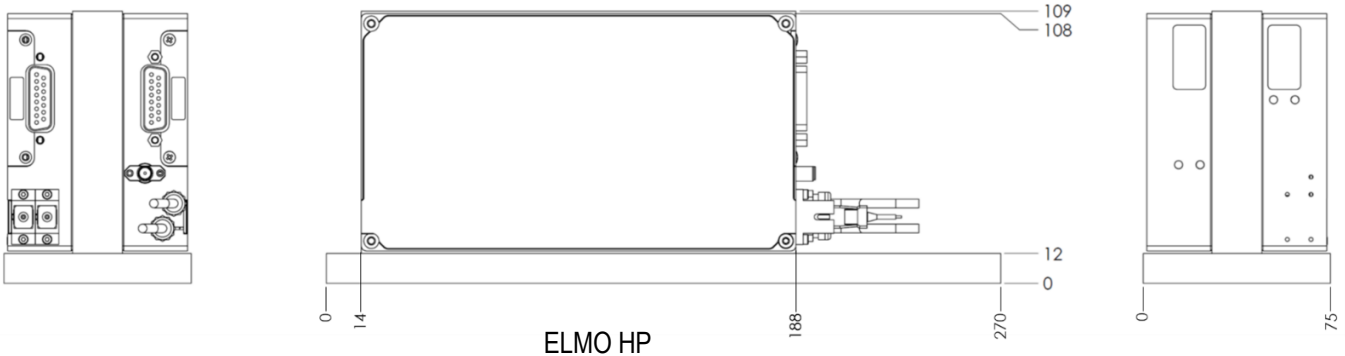

All dimensions in mm

# ELMO 780

Industry proven. Frequency doubled.

## KEY FEATURES

- Output power > 140 mW at 780 nm
- Pulse width < 60 fs at 780 nm
- Optional pulse compression and dispersion pre-compensation accessory
- Repetition rate customizable in the range 50-100 MHz
- Simple switching between 780 nm and 1560 nm output via detachable SHG unit



The frequency-doubled extension of our industry-proven ELMO series: ELMO 780 advances robustness and reliability of a 1560 nm based design concept to cover the 780 nm wavelength range. Pulses widths < 60 fs at the sample can be achieved with the optional pulse compression and dispersion pre-compensation accessory.

The ELMO 780 series is based on a fiber-coupled 1560 nm laser head (ELMO HP) and a fiber-connected handheld SHG module delivering 780 nm output – a concept that eliminates heat dissipation into optical set-ups. By simply replacing the SHG module with a fiber patch cord, the fundamental 1560 nm output is also readily available.

## PERFORMANCE DATA

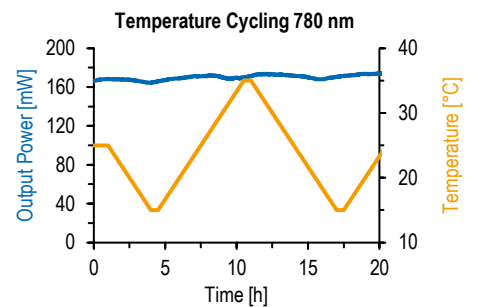
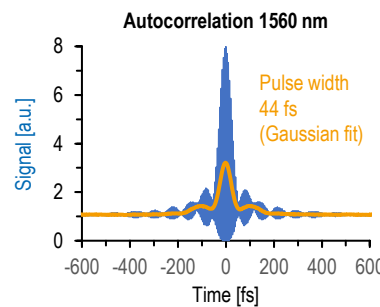
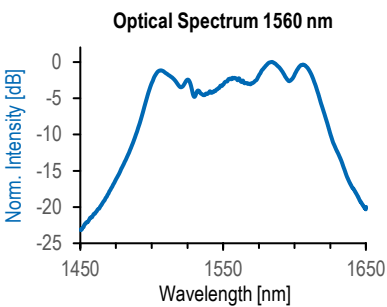
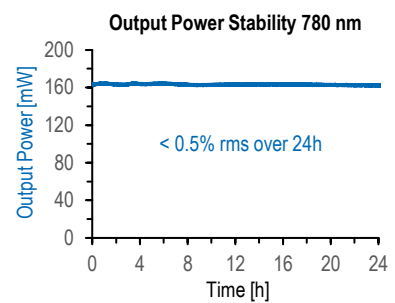
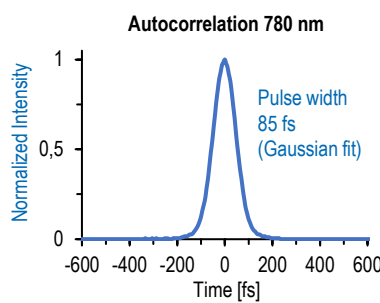
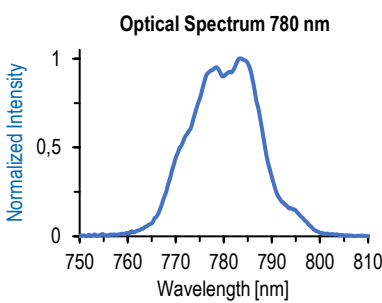



## SPECIFICATIONS

Model	ELMO 780	ELMO 780 HP
Contained Modules*	oscillator, amplifier, SHG (detachable)	

### OUTPUT CHARACTERISTICS 780 nm\*\*

Center Wavelength	780 +/- 10 nm	
Average Power	> 75 mW (typ. 85 mW)	> 140 mW (typ. 165 mW)
Pulse Width	< 100 fs (typ. 85 fs, compressible to <60 fs with optional accessory)	
Repetition Rate	100 MHz	
Output Port	free space	
Beam Quality	$M^2 < 1.2$ (typ. < 1.1)	
Polarization	linear, p-polarized***	

### OUTPUT CHARACTERISTICS 1560 nm\*\*

Center Wavelength	1560 +/- 30 nm	
Average Power	> 180 mW (typ. 210 mW)	
Pulse Width	< 70 fs (typ. < 50 fs)	
Repetition Rate	100 MHz	
Output Port	fiber-coupled (PM fiber, FC/APC connector)	
Output Fiber Length	< 0.8 m	
Polarization	linear	

### OPTIONS\*\*\*\*

Dispersion Precompensation	up to -16000 fs <sup>2</sup> (for 780 nm output)	
Repetition Rate	factory-set value in the range 50-100 MHz	
Multiple Output Ports	please inquire for additional oscillator/amplifier output ports	

### REQUIREMENTS

Warm-Up Time	< 60 s	
Operating Temperature	15 °C - 35 °C	
Operating Voltage	12 VDC (external power supply for 100/115/230 VAC included)	
Power Consumption	20 W	
Communication Options	software/USB, CAN-BUS, handheld remote unit	

### DIMENSIONS

Laser Head Dimensions / Weight	195 x 95 x 75 mm <sup>3</sup> / 2.9 kg	
SHG Module Dimensions / Weight	195 x 47 x 28 mm <sup>3</sup> / 0.5 kg	185 x 95 x 32 mm <sup>3</sup> / 1.0 kg

\* Fiber-based interconnects between all modules, standard patch cord length: 0.5 m

\*\* 780 nm: with SHG module attached, 1560 nm: with SHG module detached and replaced by PM fiber patch cord (included)

\*\*\* In standard mounting configuration, SHG module can be mounted in arbitrary orientation

\*\*\*\* Please inquire for specific combinations of pulse width, repetition rate, and average power

# ELMO XHP Series

Industry proven. Output power multiplied.

## KEY FEATURES

- Output power > 1 W at 780 nm
- Output power > 3 W at 1560 nm
- Integrated fast amplitude modulation
- Integrated dispersion precompensation up to -30.000 fs<sup>2</sup>
- Additional output ports optionally available



The most recent high power extensions of our industry-proven ELMO series: ELMO 780 XHP delivers up to 1.5 W of average output power at 780 nm, with pulse durations down to 100 fs. Fully integrated fast amplitude modulation and dispersion precompensation make it a perfect fit for multi-photon applications in microscopy or 3D nanoprinting.

For covering applications specifically at the 1560 nm fundamental, version ELMO XHP delivers up to 3 W of average output power and pulse durations down to 250 fs.

The ELMO XHP series comes in an extremely compact design, requiring just a fraction of space occupied by other lasers with comparable performance.

## PERFORMANCE DATA

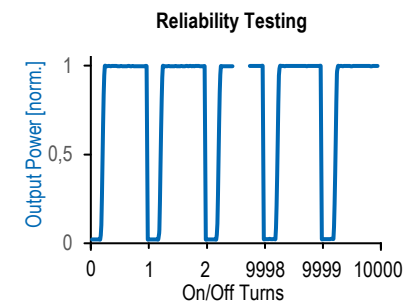
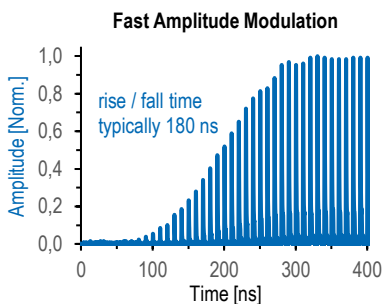
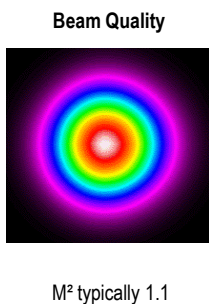
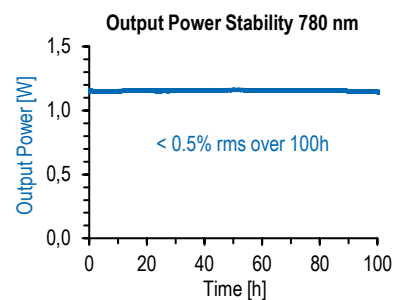
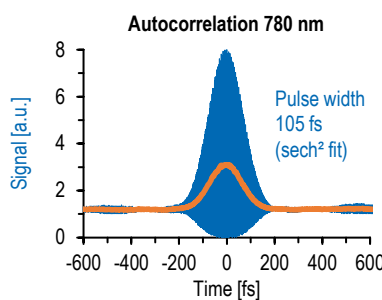
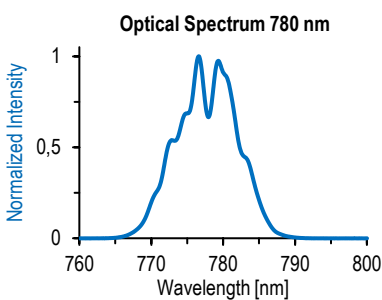

## SPECIFICATIONS

<b>Model</b>	<b>ELMO XHP</b>	<b>ELMO 780 XHP</b>
<b>Contained Modules*</b>	19" control unit, compact laser head	

## OUTPUT CHARACTERISTICS

<b>Center Wavelength</b>	1560 +/- 20 nm	780 +/- 10 nm
<b>Average Power</b>	> 3 W	> 1 W (typ. 1.2 W)
<b>Pulse Width</b>	< 300 fs (typ. 250 fs)	< 150 fs (typ. 120 fs)
<b>Repetition Rate</b>	100 MHz +/-1MHz	100 MHz +/-1MHz
<b>Output Port</b>	free space	free space
<b>Beam Quality</b>	$M^2 < 1.2$	$M^2 < 1.2$
<b>Polarization</b>	linear, s-polarized	linear, s-polarized
<b>Dispersion Precompensation</b>	n.a.	up to -30.000 fs <sup>2</sup>
<b>Fast Amplitude Modulation**</b>	n.a.	integrated AOM for fast light modulation

## OPTIONS

<b>1560 nm Output Port</b>	please inquire for additional output ports	free space, > 1 W
<b>Multiple Output Ports</b>	please inquire for additional oscillator/amplifier output ports	

## REQUIREMENTS

<b>Warm-Up Time</b>	< 60 s
<b>Operating Temperature</b>	15 °C – 35 °C
<b>Storage Temperature</b>	0°C – 50 °C
<b>Operating Voltage</b>	100/115/230 VAC
<b>Power Consumption</b>	< 150 W
<b>Communication Options</b>	software/USB

## DIMENSIONS

<b>Laser Head Dimensions / Weight</b>	240 x 170 x 65.5 mm <sup>3</sup> / < 5 kg
<b>Controller Dimensions / Weight</b>	19", 2 HU (449 x 496 x 96 mm <sup>3</sup> ) / < 20 kg
<b>Mounting</b>	detachable 12.5 mm posts and post clamps (included)

\* Control unit and laser head permanently interconnected by umbilical cord

\*\* Analog input 0-5 V, rise-/fall-time < 300 ns (typ. 180 ns)

## TECHNICAL DRAWINGS

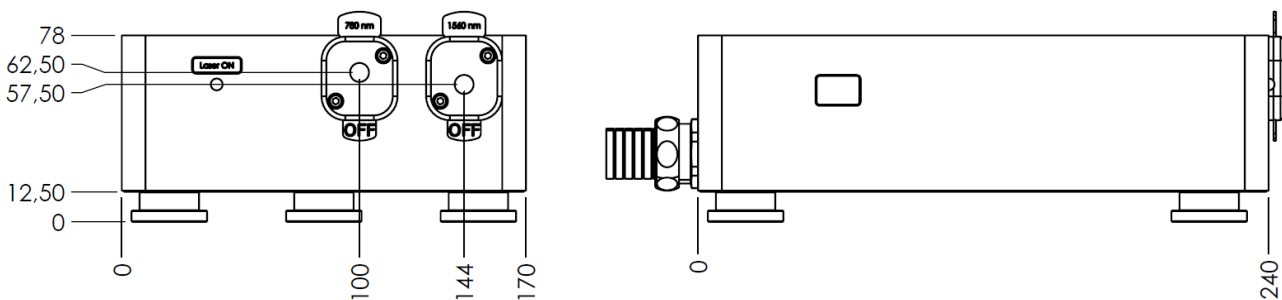

ELMO 780 XHP

All dimensions in mm

# YLMO and YLMO 930

## Multi-photons in mind

### KEY FEATURES

- Output power > 4 W at 1040 nm
- Output power > 500 mW at 930 nm
- Fully adjustable dispersion pre-compensation
- Fast amplitude modulation option
- Highest multi-photon signals from sensitive samples via low repetition rates and high pulse energies
- Compact design, easy installation, maintenance-free operation



State-of-the-art femtosecond fiber laser technology has evolved into easy-to-use products: YLMO and YLMO 930 incorporate Menlo Systems' proprietary figure 9® technology to bring excellent stability and consistent long-term performance to the life sciences and multi-photon applications. Featuring fully adjustable dispersion pre-compensation and optional fast amplitude modulation.

Installation is as easy as it gets – the compact lasers can be operated in just a few minutes with the push of a button. Operation is maintenance free and does not require any external cooling.

In short: Worry-free devices ready to serve all those who want to focus solely on their application.

### PERFORMANCE DATA

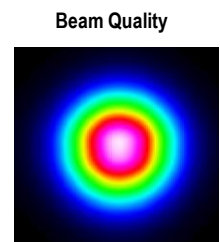
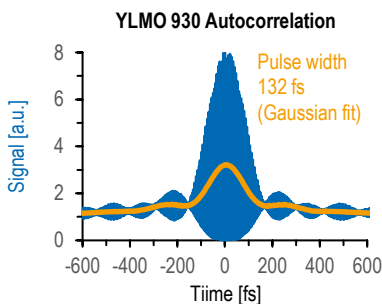
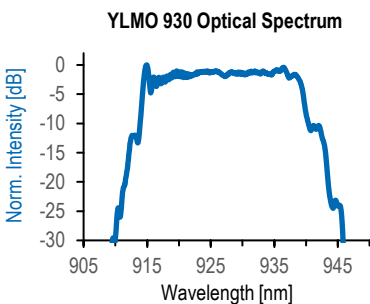
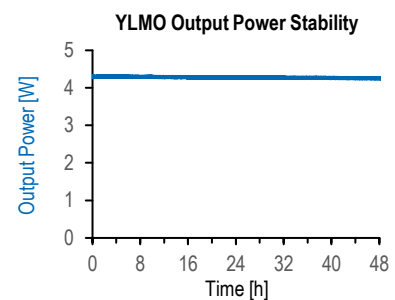
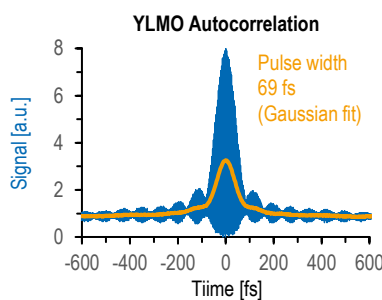
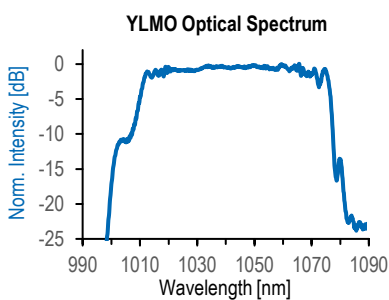

M<sup>2</sup> typically 1.1

## SPECIFICATIONS

Model	YLMO	YLMO 930
Contained Modules *	19" control unit, compact laser head	

### OUTPUT CHARACTERISTICS

Center Wavelength	1045 nm +/- 10 nm	930 nm +/- 10 nm
Average Power	> 4 W	> 500 mW
Pulse Energy	> 40 nJ	> 10 nJ
Pulse Width	< 80 fs (typ. 70 fs)	< 140 fs (typ. 130 fs)
Bandwidth	> 30 nm	> 20 nm
Repetition Rate	100 MHz	50 MHz
Output Port	free space	
Beam Quality	$M^2 < 1.2$ (typ. 1.1)	
Polarization	linear, p-pol (> 100:1)	linear, p-pol (> 50:1)
Beam Diameter	2.0 mm +/- 0.5 mm	
Beam Divergence	< 2 mrad	
Dispersion Precompensation	0 fs <sup>2</sup> to -30.000 fs <sup>2</sup>	0 fs <sup>2</sup> to -60.000 fs <sup>2</sup>

### OPTIONS

Repetition Rate	factory-set value in the range 80-100 MHz	n.a.
Fast Amplitude Modulation **	integrated AOM for fast amplitude control	

### REQUIREMENTS

Warm-up Time	< 60 s
Operating Temperature	15 °C - 30 °C
Operating Voltage	110 / 115 / 230 VAC, 50 to 60 Hz
Power Consumption	200 W
Communication	software/USB

### DIMENSIONS

Laser Head Dimensions / Weight	265 x 110 x 76 mm <sup>3</sup> / < 5 kg
Control Unit Dimensions / Weight	19", 2 HU (449 x 496 x 96 mm <sup>3</sup> ) / < 20 kg
Umbilical Cord Length ***	2 m
Mounting	detachable 25 mm posts and post clamps (included)

\* Control unit and laser head permanently interconnected by umbilical cord

\*\* Analog or digital input, rise time <1 μs

\*\*\* Custom umbilical cord lengths available on request

### TECHNICAL DRAWINGS

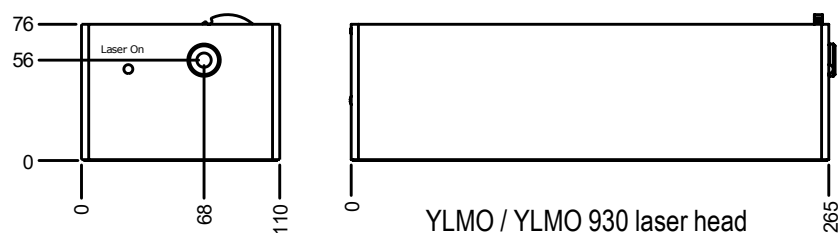

All dimensions in mm

# YLMO 520

Two wavelengths, one choice

## KEY FEATURES

- 520 nm and 1040 nm dual output
- Output power > 0.5 W at 520 nm (pulse width < 150 fs)
- Output power > 4 W at 1040 nm (pulse width < 100 fs)
- Arbitrary power splitting ratio
- Highly compact design
- Fast amplitude modulation option



Frequency doubling meets versatility: YLMO 520, the frequency doubled extension of our YLMO series, delivers > 0.5 W of average output power at 520 nm, with pulse durations below 150 fs. Its design permits simultaneous access to the 1040 nm fundamental with an arbitrary power splitting ratio.

YLMO 520 comes in a highly compact design – with fast amplitude modulation optionally integrated.

High peak powers, excellent stability, and consistent long-term performance make YLMO 520 a perfect fit for applications such as multi-photon excitation, pump-probe spectroscopy, or two-photon polymerization.

## PERFORMANCE DATA

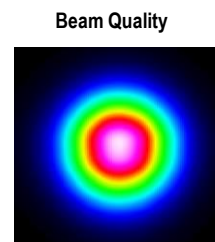
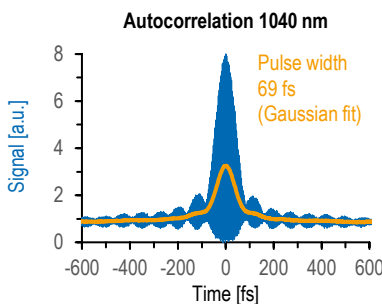
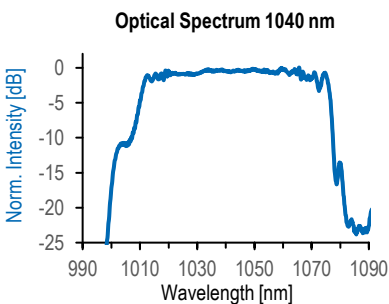
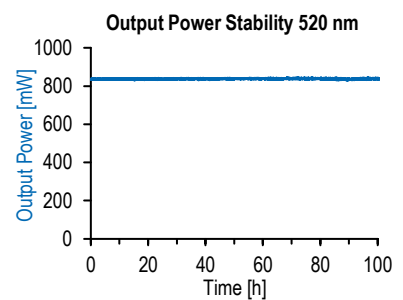
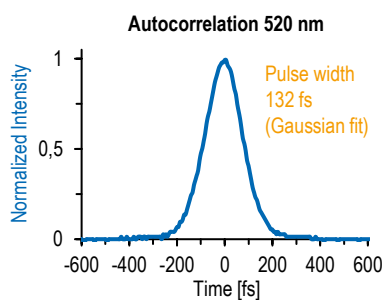
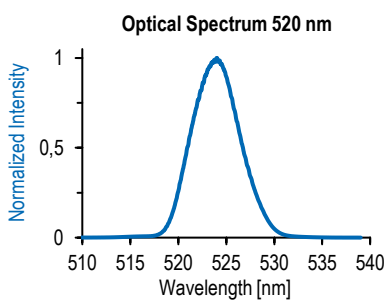

M<sup>2</sup> typically 1.1

## SPECIFICATIONS

<b>Model</b>	<b>YLMO 520</b>
<b>Contained Modules *</b>	19" control unit, compact laser head

### OUTPUT CHARACTERISTICS

	520 nm Output Port	1040 nm Output Port
<b>Center Wavelength</b>	520 nm +/- 5 nm	1045 nm +/- 10 nm
<b>Average Power **</b>	> 0.5 W	> 4 W
<b>Pulse Energy</b>	> 5 nJ	> 40 nJ
<b>Pulse Width</b>	< 150 fs	< 100 fs
<b>Bandwidth</b>	> 5 nm	> 30 nm
<b>Repetition Rate</b>	100 MHz	
<b>Output Port</b>	free space	
<b>Beam Quality</b>	M <sup>2</sup> < 1.2 (typically 1.1)	
<b>Polarization</b>	linear, s-pol	linear, p-pol
<b>Beam Diameter</b>	2.0 mm +/- 0.5 mm	
<b>Beam Divergence</b>	< 2 mrad	

### OPTIONS

<b>Fast Amplitude Modulation ***</b>	integrated AOM for fast amplitude control
--------------------------------------	---

### REQUIREMENTS

<b>Warm-up Time</b>	< 60 s
<b>Operating Temperature</b>	15 °C - 30 °C
<b>Operating Voltage</b>	100-120 V (50/60Hz), 200-240 V (50/60Hz)
<b>Power Consumption</b>	200 W
<b>Communication</b>	software/USB

### DIMENSIONS

<b>Laser Head Dimensions / Weight</b>	265 x 220 x 113 mm <sup>3</sup> / < 10 kg
<b>Control Unit Dimensions / Weight</b>	19", 2 HU (449 x 496 x 96 mm <sup>3</sup> ) / < 20 kg
<b>Umbilical Cord Length ****</b>	2 m

- \* Control unit and laser head permanently interconnected by umbilical cord
- \*\* User can switch between 520 nm and 1040 nm output port, arbitrary power splitting ratios possible
- \*\*\* Analog or digital input, rise time < 1 μs
- \*\*\*\* Custom umbilical cord lengths available on request

### TECHNICAL DRAWINGS

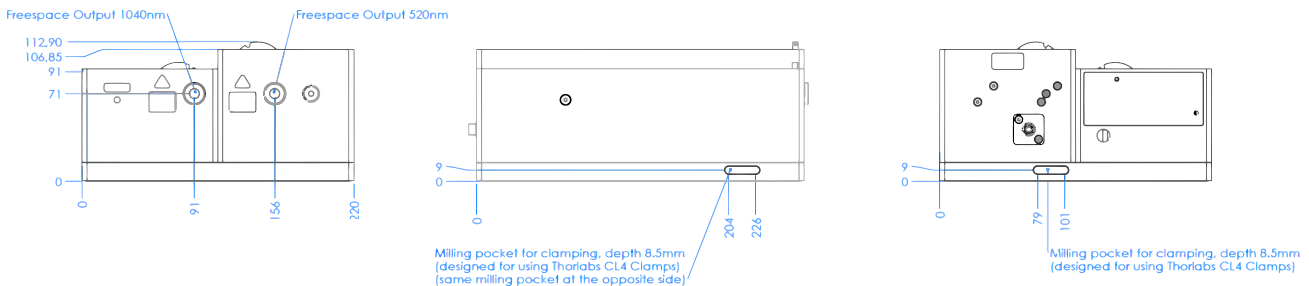

YLMO 520 laser head

All dimensions in mm

# YLMO Mid-IR

## Unique solution for unique fingerprints

### KEY FEATURES

- Tunable output wavelength 3 - 5  $\mu\text{m}$
- Typical output power > 100 mW
- Typical pulse width < 200 fs
- Large spectral bandwidth up to 300  $\text{cm}^{-1}$
- Highly compact design
- Optional repetition rate stabilization for mid-IR frequency comb generation



Powerful, tunable, compact: YLMO Mid-IR delivers femtosecond pulses in the mid-IR with typical output powers > 100 mW, tunable across the 3-5  $\mu\text{m}$  wavelength range.

Pulse widths < 200 fs align to applications in both the frequency and time domain. A compact design ensures high stability without the need for realignment.

YLMO Mid-IR delivers carrier-envelope-offset-free pulse trains, suitable for mid-IR frequency comb generation via optional stabilization of the repetition rate.

No matter the mid-IR spectroscopy to be carried out, YLMO Mid-IR is a convenient, cost-effective, and high-brilliance mid-IR source that can be installed within a few minutes.

### PERFORMANCE DATA

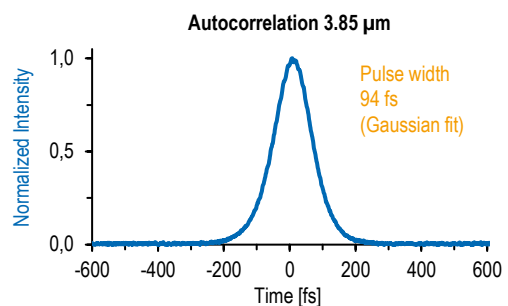
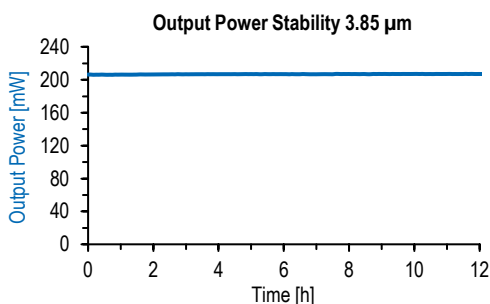
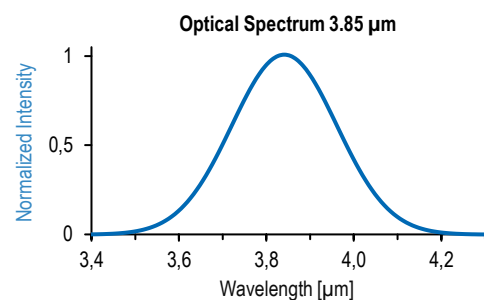
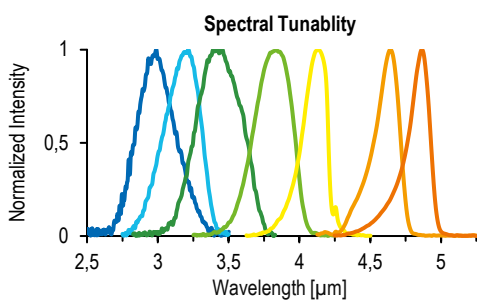



## SPECIFICATIONS

<b>Model</b>	<b>YLMO Mid-IR</b>
<b>Contained Modules *</b>	19" control unit, compact laser head

### OUTPUT CHARACTERISTICS

<b>Center Wavelength</b>	3 – 5 $\mu\text{m}$ (tunable)
<b>Average Power **</b>	> 100 mW in the range 3.0 - 4.7 $\mu\text{m}$ , > 80 mW in the range 4.7 - 5.0 $\mu\text{m}$
<b>Pulse Energy **</b>	> 1 nJ in the range 3.0 - 4.7 $\mu\text{m}$ , > 0.8 nJ in the range 4.7 - 5.0 $\mu\text{m}$
<b>Pulse Width **</b>	< 400 fs (typ. 200 fs)
<b>Bandwidth</b>	up to 300 $\text{cm}^{-1}$
<b>Repetition Rate **</b>	100 MHz
<b>Output Port</b>	free space
<b>Polarisation</b>	linear, s-polarized

### OPTIONS

<b>Center Wavelength</b>	fixed wavelength on request
<b>Repetition Rate</b>	stabilized (for mid-IR frequency comb generation)
<b>Output Port</b>	fiber-coupled

### REQUIREMENTS

<b>Warm-up Time</b>	< 60s
<b>Operating Temperature</b>	15 °C - 30 °C
<b>Operating Voltage</b>	100-120 V (50/60 Hz), 220-240 V (50/60 Hz)
<b>Power Consumption</b>	200 W
<b>Communication</b>	software/USB

### DIMENSIONS

<b>Laser Head Dimensions / Weight</b>	340 x 290 x 90 $\text{mm}^3$ , < 10 kg
<b>Control Unit Dimensions / Weight</b>	19", 2 HU (449 x 496 x 96 $\text{mm}^3$ ) / < 20 kg
<b>Umbilical Cord Length ***</b>	2 m

\* Control unit and laser head permanently interconnected by umbilical cord

\*\* Please inquire for specific combinations of average power, pulse width, and repetition rate

\*\*\* Custom umbilical cord lengths available on request

### TECHNICAL DRAWINGS

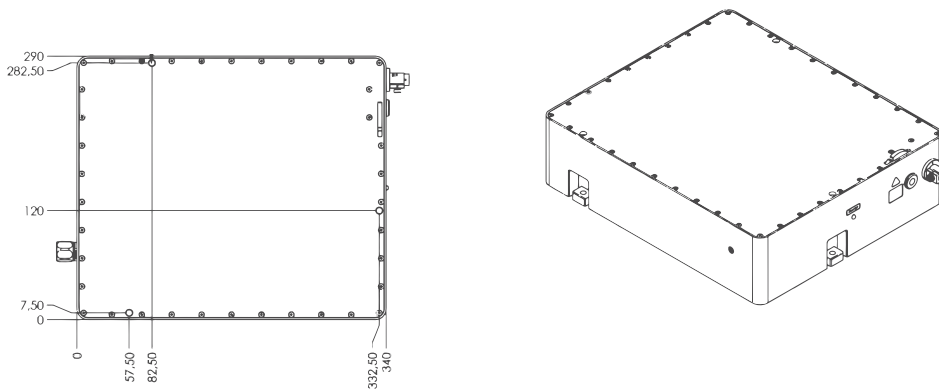

YLMO Mid-IR laser head

All dimensions in mm

# YLMO-Seed

## Straightforward amplifier seeding

### KEY FEATURES

- Center wavelength 1030 - 1064 nm
- Output power > 200 mW
- Repetition rate 30 - 100 MHz
- > 15 nm bandwidth, supporting < 150 fs pulse widths
- Highly customizable
- Easy to integrate



Simply made for seeding laser amplifiers: YLMO-Seed combines all the benefits of Menlo Systems' figure 9® mode locking technology into a highly-customizable seed source. An all polarization-maintaining (PM) fiber design with a single mode-locked state ensures reliable and consistent mode locking, low amplitude and phase noise, and excellent long term stability.

The YLMO-Seed will readily align to even the most challenging applications via a customizable center wavelength, spectral bandwidth, repetition rate, configuration of output ports, length and type of output fiber, and optional fast amplitude modulation. In short: An amplifier seed source as flexible as it is easy to integrate.

### PERFORMANCE DATA

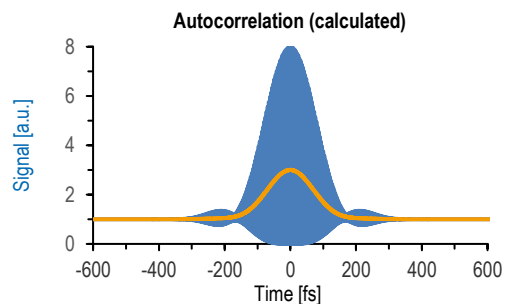
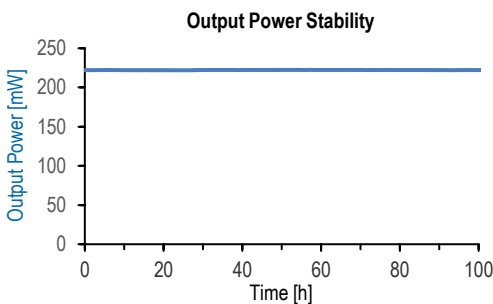
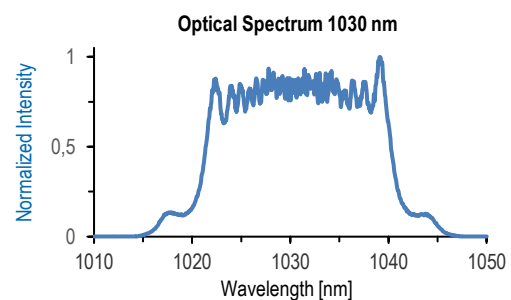
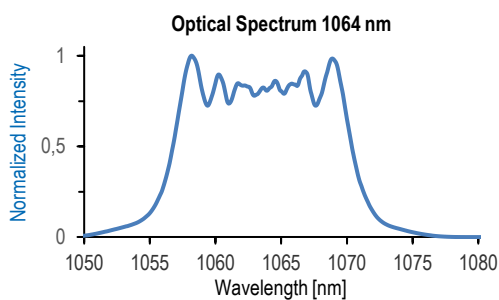

## SPECIFICATIONS

<b>Model</b>	<b>YLMO-Seed</b>
<b>Contained Modules</b>	19" control unit

### OUTPUT CHARACTERISTICS \*

<b>Center Wavelength</b>	factory set between 1030 nm and 1064 nm, +/- 1 nm
<b>Average Power</b>	> 200 mW (@ 50 MHz)
<b>Pulse Energy</b>	> 4 nJ (@ 50 MHz)
<b>Pulse Width</b>	chirped
<b>Bandwidth (3dB)</b>	> 15 nm (supporting < 150 fs)
<b>Repetition Rate</b>	50 MHz
<b>Output Port</b>	fiber coupled (PM fiber, SC/APC mating sleeve)
<b>Polarization</b>	linear (> 100:1)

### OPTIONS

<b>Bandwidth</b>	customized narrow spectral bandwidth
<b>Repetition Rate</b>	factory-set value in the range 30-100 MHz
<b>Multiple Output Ports</b>	customized additional output ports for seeding multiple amplifiers
<b>Output Port</b>	customized length and type of output fiber
<b>Fast Amplitude Modulation **</b>	integrated AOM for fast amplitude control

### REQUIREMENTS

<b>Warm-up Time</b>	< 60 s
<b>Operating Temperature</b>	15 °C - 35 °C
<b>Operating Voltage</b>	110 / 115 / 230 VAC, 50 to 60 Hz
<b>Power Consumption</b>	120 W
<b>Communication</b>	software/USB

### DIMENSIONS

<b>Laser Unit Dimensions / Weight</b>	19" x 2 HU x 495 mm / 15 kg
---------------------------------------	-----------------------------

\* Please inquire for specific combinations of center wavelength, average power, bandwidth, and repetition rate

\*\* Analog or digital input, rise time <1 μs

### TECHNICAL DRAWINGS

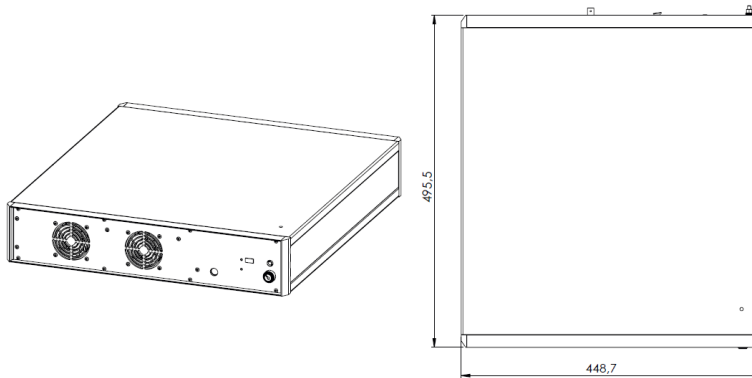

YLMO Seed

All dimensions in mm

# C-Fiber

## Flagship laser full of options

### KEY FEATURES

- Output power > 500 mW at 1560 nm
- Pulse width < 90 fs
- Lowest pulse-to-pulse timing jitter
- Optional intra-cavity actuators for repetition rate tuning
- Repetition rate stabilization, locking, and synchronization via repetition rate locking electronics (RRE Synchro)
- Optional multiple output ports, second harmonic and supercontinuum generation



The flagship of our scientific laser series: C-Fiber comes with a whole range of options to cover the application in mind – ranging from customized repetition rates, intracavity actuators for repetition rate stabilization and synchronization, multiple output ports, to modules for frequency conversion like second harmonic or supercontinuum generation.

The C-Fiber series is based on a fully PM fiber design and uses active temperature stabilization to provide lowest pulse-to-pulse timing jitter, low amplitude and phase noise, and excellent long-term stability. No matter the configuration, all systems can be user installed within minutes, are ready to use at the push of a button, and are entirely maintenance free.

### PERFORMANCE DATA

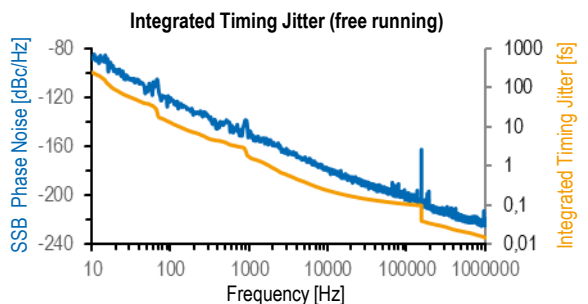
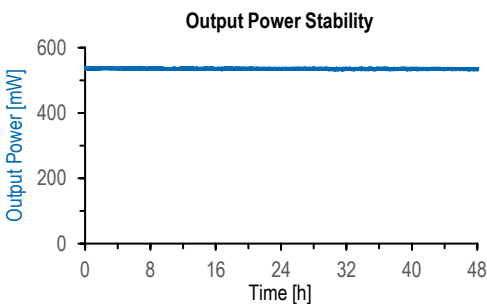
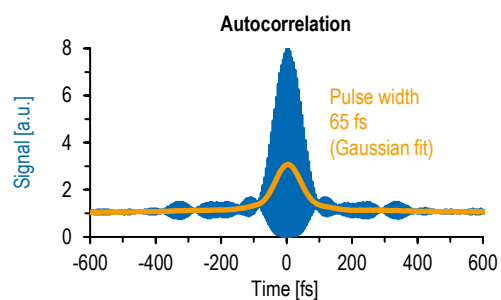
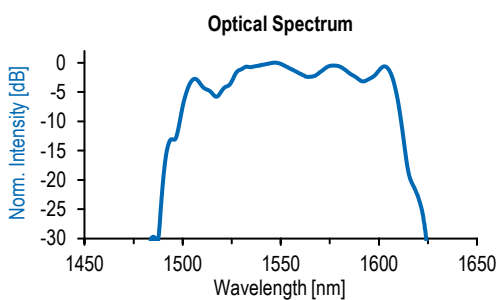

## SPECIFICATIONS

Model	C-Fiber	C-Fiber HP
-------	---------	------------

### OUTPUT CHARACTERISTICS

Center Wavelength	1560 +/- 20 nm	
Average Power	> 100 mW	> 500 mW
Pulse Energy	> 1 nJ	> 5 nJ
Pulse Width	< 90 fs	
Repetition Rate	100 MHz	
Repetition Rate Stability	< 1 ppm over 20 hours (free running)	
Timing Jitter	< 2 fs rms [10kHz -1MHz] (free running)	
Output Port	fiber coupled (FC/APC)	free space
Polarization	linear, PM fiber	linear, s-pol
Additional Seed Port	one additional seed port	

### OPTIONS

Repetition Rate	factory-set value in the range 50-250 MHz
Repetition Rate Tuning	optional intra-cavity actuators for repetition rate tuning
Repetition Rate Stabilization, Locking, and Synchronization *	optional repetition rate locking electronics (RRE Synchro)
Multiple Output Ports	additional output ports for seeding multiple amplifiers and/or frequency conversion
Supercontinuum Extension	NIR [1050 - 2100 nm]

### REQUIREMENTS

Warm-Up Time	< 60 s
Operating Temperature	15 °C - 35 °C
Operating Voltage	100/115/230 VAC
Power Consumption	120 VA
Communication Options	software/USB, CAN-BUS

### DIMENSIONS

Laser Head Dimensions / Weight	413 x 90 x 178 mm <sup>3</sup> / 7 kg	413 x 120 x 178 mm <sup>3</sup> / 10 kg
Control Unit Dimensions / Weight	448 x 132 x 437 mm <sup>3</sup> / 10 kg	448 x 132 x 437 mm <sup>3</sup> / 12 kg

\* Requires optional intra-cavity actuators for repetition rate tuning

### TECHNICAL DRAWINGS

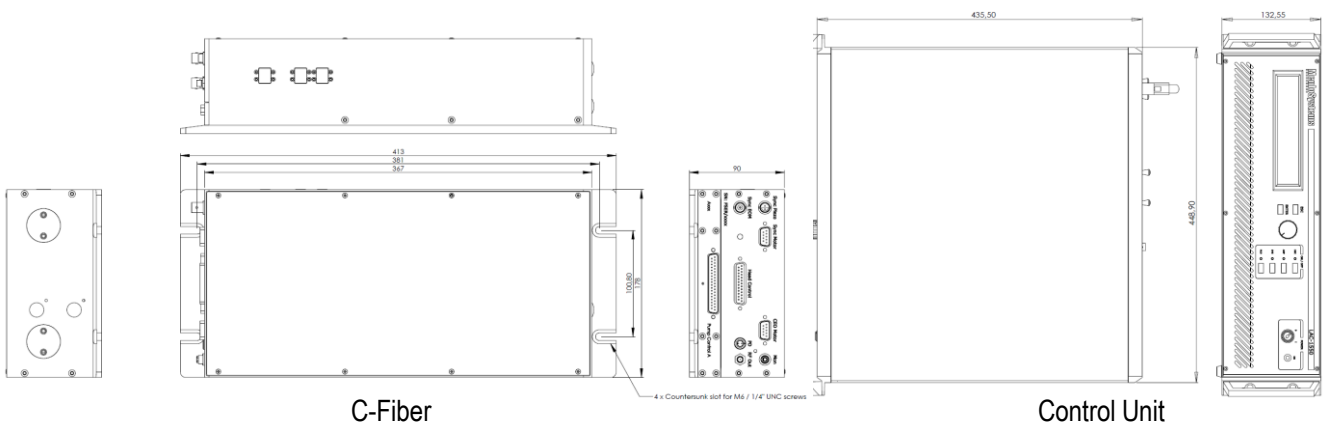

All dimensions in mm

# C-Fiber 780

Frequency doubled. Options multiplied.

## KEY FEATURES

- Output power > 250 mW at 780 nm
- Pulse width < 70 fs
- Lowest pulse-to-pulse timing jitter
- Optional intra-cavity actuators for repetition rate tuning
- Repetition rate stabilization, locking, and synchronization via repetition rate locking electronics (RRE Synchro)
- 780 nm and 1560 nm dual output



Options multiplied: C-Fiber 780 expands the versatility of our scientific series to the 780 nm range. Options include: Integrated pulse compression, customizable repetition rates, repetition rate stabilization and synchronization, multiple output ports, and optional supercontinuum generation. The design permits simultaneous access to the 1560 nm fundamental at an arbitrary power splitting ratio.

The C-Fiber series is based on a fully PM fiber design and uses active temperature stabilization to provide lowest pulse-to-pulse timing jitter, low amplitude and phase noise, and excellent long-term stability.

No matter the configuration, all systems can be user installed within minutes, are ready to use at the push of a button, and are entirely maintenance free.

## PERFORMANCE DATA

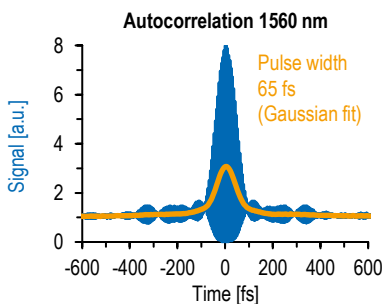
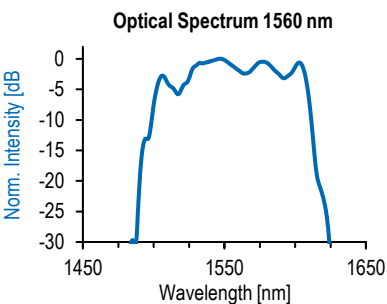
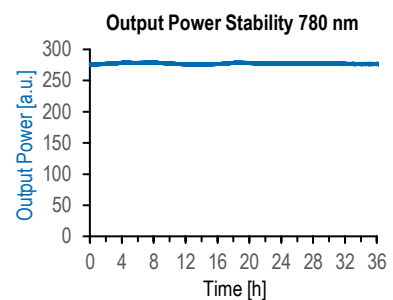
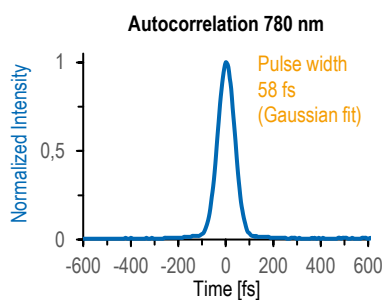
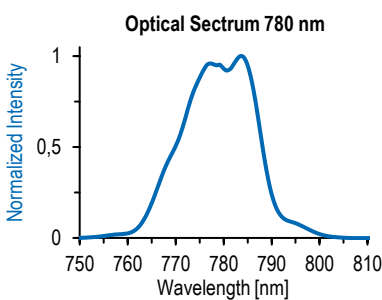

Beam quality 780 nm

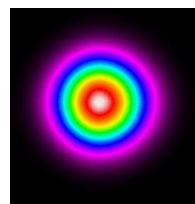

M<sup>2</sup> typically 1.1

## SPECIFICATIONS

Model	C-Fiber 780	C-Fiber 780 HP
-------	-------------	----------------

### OUTPUT CHARACTERISTICS 780 nm \*

Center Wavelength	780 +/- 10 nm	
Average Power	> 100 mW	> 250 mW
Pulse Energy	> 1 nJ	> 2.5 nJ
Pulse Width	< 100 fs (< 70 fs with optional pulse compression)	
Repetition Rate	100 MHz	
Repetition Rate Stability	< 1 ppm over 20 hours (free running)	
Timing Jitter	< 2 fs rms [10kHz -1MHz] (free running)	
Output Port	free space	
Polarization	linear, s-pol	

### OUTPUT CHARACTERISTICS 1560 nm \*

Center Wavelength	1560 +/- 20 nm	
Average Power	> 250 mW	> 500 mW
Pulse Energy	> 2.5 nJ	> 5 nJ
Pulse Width	< 90 fs	
Repetition Rate	100 MHz	
Repetition Rate Stability	< 1 ppm over 20 hours (free running)	
Timing Jitter	< 2 fs rms [10kHz -1MHz] (free running)	
Output Port	free space	
Polarization	linear, s-pol	
Additional Seed Port	one additional seed port	

### OPTIONS

Pulse Compression 780 nm	optionally integrated pulse compression for < 70 fs pulse width at 780 nm
Repetition Rate	factory-set value in the range 50-250 MHz
Repetition Rate Tuning	optional intra-cavity actuators for repetition rate tuning
Repetition Rate Stabilization, Locking, and Synchronization **	optional repetition rate locking electronics (RRE Synchro)
Multiple Output Ports	additional output ports for seeding multiple amplifiers and/or frequency conversion
Supercontinuum Extension	VIS [550-1050 nm] and/or NIR [1050-2100 nm]

### REQUIREMENTS

Warm-Up Time	< 60 s
Operating Temperature	15 °C - 35 °C
Operating Voltage	100/115/230 VAC
Power Consumption	120 VA
Communication Options	software/USB, CAN-BUS

### DIMENSIONS

Laser Head Dimensions / Weight	415 x 350 x 110 mm <sup>3</sup> / 18 kg	415 x 350 x 140 mm <sup>3</sup> / 20 kg
Control Unit Dimensions / Weight	448 x 132 x 437 mm <sup>3</sup> / 10 kg	448 x 132 x 437 mm <sup>3</sup> / 12 kg

\* User can switch between 780 nm and 1560 nm output port, arbitrary power splitting ratios possible

\*\* Requires optional intra-cavity actuators for repetition rate tuning

# Orange

## Versatile enabler for versatile research

### KEY FEATURES

- Output power > 10 W at 1040 nm
- Pulse width < 75 fs at 1040 nm
- Lowest pulse-to-pulse timing jitter
- Optional intra-cavity actuators for repetition rate tuning
- Repetition rate stabilization, locking, and synchronization via repetition rate locking electronics (RRE Synchro)
- Optional multiple output ports, second harmonic and supercontinuum generation



A true allrounder: The Orange series is a highly versatile 1040 nm scientific platform, available as a low power oscillator or in amplified versions with up to > 10 W average power and pulse widths < 75 fs. Options include integrated pulse compression, customizable repetition rates, repetition rate stabilization and synchronization, and multiple output ports.

For wavelength conversion to the visible spectral range, an efficient frequency-doubling extension is readily available. Like all of our scientific platforms, Orange is based on a fully PM fiber design and uses active temperature stabilization to provide lowest pulse-to-pulse timing jitter, low amplitude and phase noise, and excellent long term stability.

### PERFORMANCE DATA

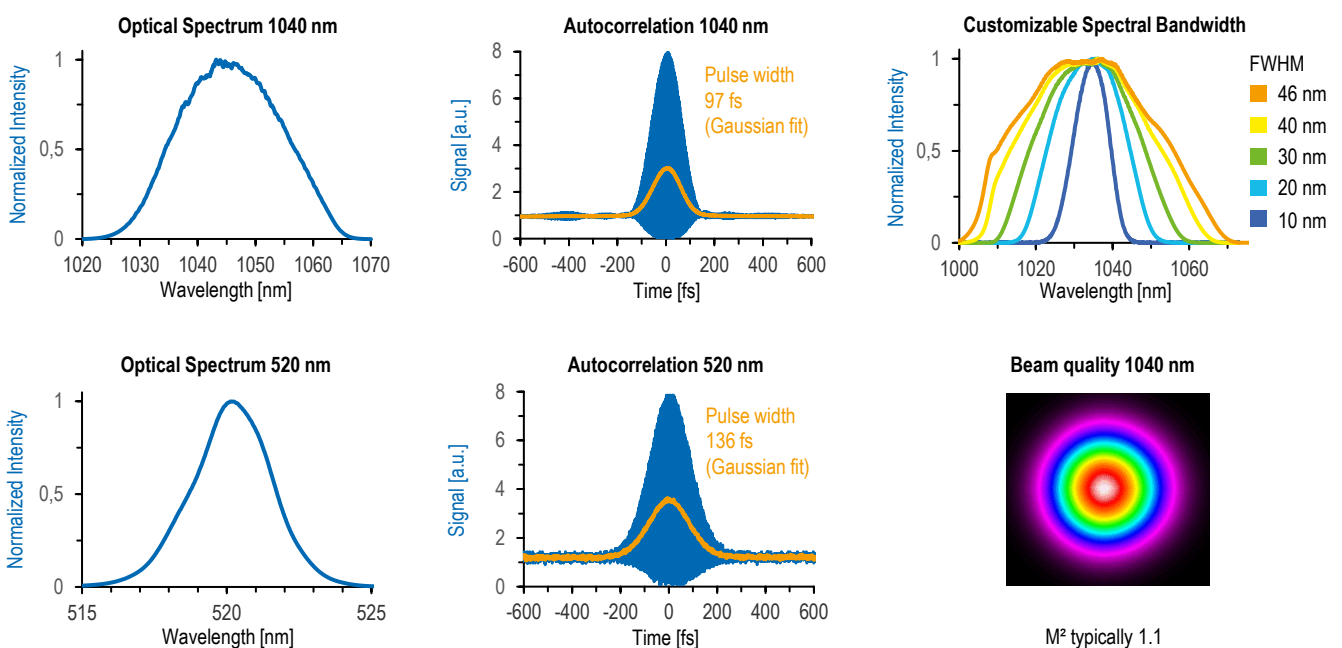



## SPECIFICATIONS

Model	orange	orange HP	orange HP10
-------	--------	-----------	-------------

### OUTPUT CHARACTERISTICS 1040 nm

Center Wavelength	1040 nm +/- 10 nm		
Average Power	> 100 mW	> 1 W	> 10 W
Pulse Energy	> 1 nJ	> 10 nJ	> 100 nJ
Pulse Width	chirped, supporting < 150fs	< 150 fs (< 75 fs)*	< 200 fs (< 150 fs)*
Repetition Rate	100 MHz		
Output port	fiber coupled	free space	
Polarization	linear, PM fiber	linear, p-pol	
Beam Quality	n.a.	M <sup>2</sup> < 1.2 (typically 1.1)	
Additional Seed Port	one additional seed port		

### OUTPUT CHARACTERISTICS 520 nm \*\*

Center Wavelength	520 nm +/- 5 nm
Average Power	> 400 mW
Pulse Energy	> 4 nJ
Pulse Width	< 150 fs
Repetition Rate	100 MHz

### OPTIONS

Pulse Compression 1040 nm	n.a.	optionally integrated pulse compression
Repetition Rate ***	factory-set value in the range 50-250 MHz	
Repetition Rate Tuning	optional intra-cavity actuators for repetition rate tuning	
Repetition Rate Stabilization, Locking, and Synchronization ****	optional repetition rate locking electronics (RRE Synchro)	
Multiple Output Ports	additional output ports for seeding multiple amplifiers and/or frequency conversion	
Supercontinuum Extension	n.a.	VIS to NIR [650-1550 nm]

### REQUIREMENTS

Warm-Up Time	< 60 s
Operating Temperature	22 +/- 3 °C
Operating Voltage	100/115/230 VAC
Communication Options	software/USB, CAN-BUS

### DIMENSIONS

Laser Head Dimensions / Weight	413 x 178 x 120 mm <sup>3</sup> / 10 kg	415 x 400 x 140 mm <sup>3</sup> / 26 kg	415 x 400 x 140 mm <sup>3</sup> / 26 kg
Control Unit Dimensions / Weight	448 x 132 x 437 mm <sup>3</sup> / 10 kg	448 x 132 x 437 mm <sup>3</sup> / 11 kg	448 x 227 x 495 mm <sup>3</sup> / 25 kg

\* With optional pulse compression for shorter pulse widths

\*\* With optional second harmonic module SHG 520

\*\*\* Please inquire for specific combinations of average power, pulse duration, and repetition rate

\*\*\*\* Requires optional intra-cavity actuators for repetition rate tuning

# RRE-SYNCRO locking electronics

## Tracking the pulse of time

### KEY FEATURES

- Plug & play electronics platform for repetition rate stabilization, locking, and synchronization
- Highly versatile modular concept configurable for a wide range of synchronization tasks
- Superior phase sensitivity through harmonic lock
- Support of third party laser systems and actuators
- Individually tested phase noise performance



Precision control: Whether stabilizing the repetition rate of a laser, locking it to an external reference, or synchronizing two lasers in a master/slave configuration, the RRE-SYNCRO will adapt to a wide range of applications. Fundamental and harmonic locking capabilities enable superior phase sensitivity, and a highly-versatile modular concept ensures optimal integration and interfacing.

The RRE-SYNCRO can be operated via an integrated touchscreen, or operated remotely via a user-friendly software interface. While designed for compatibility with Menlo Systems' scientific laser series, a wide range of third party laser systems and actuators are also supported.

### PERFORMANCE DATA

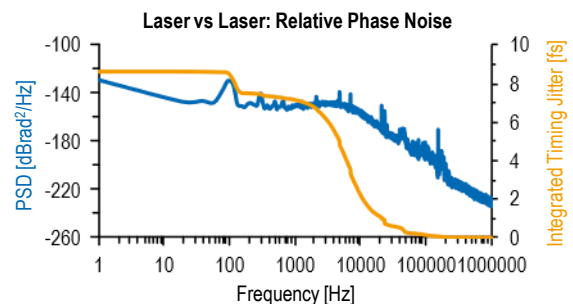
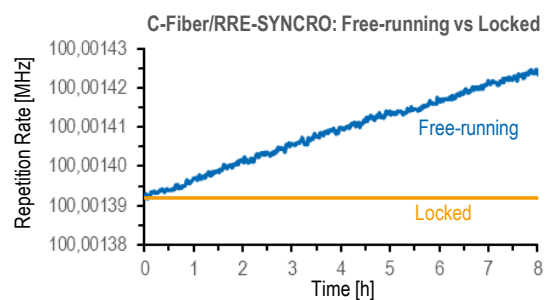
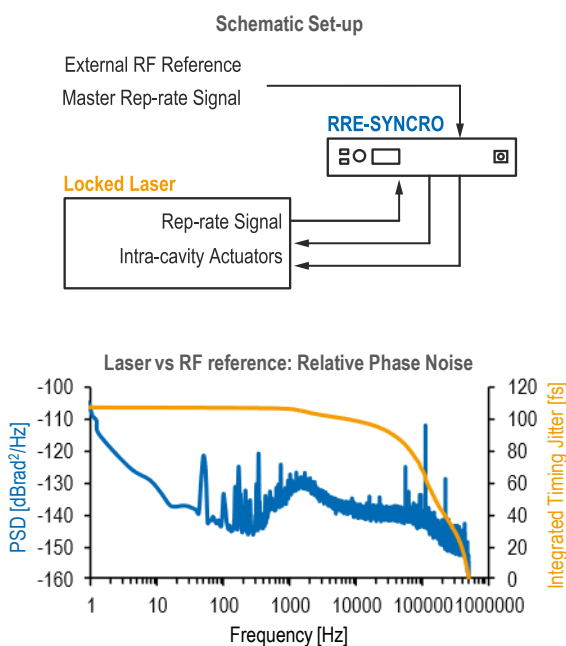

## SPECIFICATIONS

<b>Model</b>	<b>RRE-SYNPRO</b>
--------------	-------------------

### CHARACTERISTICS

<b>RMS Timing Jitter</b>	< 200 fs [0.1 Hz - 500 kHz] or same as reference, whichever applies first *
<b>External Reference Options</b>	Master laser repetition rate signal
	Harmonic master laser repetition rate signal (RF or optical)
	10 MHz RF reference signal (external or generated internally)
<b>Stepper Motor Signal Output</b>	Sub-D, 9 pin
<b>Piezo Signal Output</b>	BNO
<b>Error Signal Output</b>	BNC

### OPTIONS

<b>Custom Reference Frequencies</b>	Depending on filter availability
<b>Custom Phase Detectors</b>	For low drift
<b>External RF Phase Detector</b>	For reference frequency > 1GHz and enhanced timing jitter performance
<b>Adjustable Offset</b>	To set the relative time delay between laser pulses and reference signal
<b>Tunable Repetition Rate</b>	Locking schemes with tunable repetition rates
<b>Repetition Rate Lock Automation</b>	Via RRE-Control software
<b>Reference Generation Electronics</b>	10 or 20 MHz clock module (higher frequencies via integrated phase locked oscillator)

### REQUIREMENTS

<b>Storage Temperature</b>	0 °C – 40 °C
<b>Operating Voltage</b>	110/220 V
<b>Communication</b>	USB

### DIMENSIONS

<b>Dimensions / Weight</b>	449 x 134 x 435 mm <sup>3</sup> / 7 kg (19", 3U)
----------------------------	--

\* Values specified for models of the C-Fiber femtosecond fiber laser series. Please contact us when stabilizing lasers from other manufacturers to optimize the performance of the RRE locking electronics

# Technology primer

## Why 9 cuts a good figure



**figure 9**® stands for Menlo Systems' proprietary fiber laser design<sup>1</sup>, with the name derived from the characteristic shape of the cavity scheme employed. This primer explains the basic principles behind the technology - and the unique advantages it offers.

### MODE LOCKING

In simple terms, mode locking can be considered as a prerequisite to generate femtosecond laser pulses. It involves designing a laser cavity with operational conditions such that the cavity modes will reliably self-organize into a stable train of ultrashort pulses, with as little unwanted background and noise as possible.

In femtosecond fiber lasers, this has often been achieved by employing so-called intrinsic saturable absorbers - materials whose absorption decreases at high optical intensities. However, besides potential degradation over time, intrinsic effects related to their slow relaxation times may cause excessive noise floors<sup>2</sup>, which is detrimental to precision applications like optical frequency combs. This has driven our search for a superior alternative: A fast mode-locking scheme based on effects other than absorption.

### FIBER LOOP MIRRORS

For an intuitive picture, we refer to a fiber coupler that splits a light pulse arriving at one of its input ports into two equal portions (Fig.1/①). Connecting the output ports by a fiber loop, the two portions will propagate in opposite directions and interfere again at the splitter (Fig.1/②). In the simplest case, this will result in the original pulse being reflected back to where it came from, and the fiber loop acts like a mirror (Fig. 1/③).

The reflectivity of the loop mirror changes if the two counterpropagating pulses for some reason acquire a phase shift relative to each other before interfering. The phase shift will affect the interference conditions such that a certain fraction of the original input pulse will be transmitted into the second input port, rather than being reflected (Fig.1/④). Now, if the ratio of transmission to reflection can be designed to depend on the intensity of the original input pulse, the fiber loop may act as an artificial fast saturable absorber.

### NONLINEAR AMPLIFYING LOOP MIRRORS

An implementation of this principle, shown in the upper part of Fig. 2, is commonly referred to as nonlinear amplifying loop mirror (NALM). It relies on an asymmetric arrangement of an amplifying section of doped fiber and a long section of undoped fiber.

The principle of the NALM relies on the phase shift between pulses that are first amplified before propagating in the long fiber, and pulses travelling in the opposite direction: The former experience a stronger intensity-dependent nonlinearity during the round trip. For an increasing nonlinear phase difference, and hence input pulse intensity, the transmission of the NALM increases, very much analogous to a saturable absorber.

As shown in Fig. 2, mode-locked laser operation can thus be achieved in a so-called figure-of-eight laser. A major drawback of this configuration, however, is the difficulty to achieve self-starting mode-locked operation when using polarization-maintaining fibers.

<sup>1</sup> Patents EP 2637265 A1 / CN 103311780 A / US 8873601 B2

<sup>2</sup> Excess carrier-envelope phase noise generation in saturable absorbers, N. Raabe et al., Optics Lett. (2017), Vol. 42, No. 6, 1068



# Technology Primer

Why 9 cuts a good figure

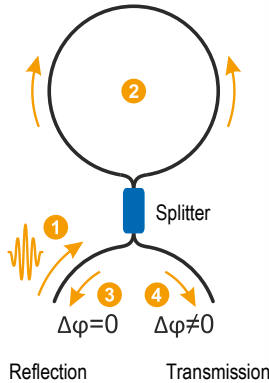

Figure 1. Fiber loop mirror

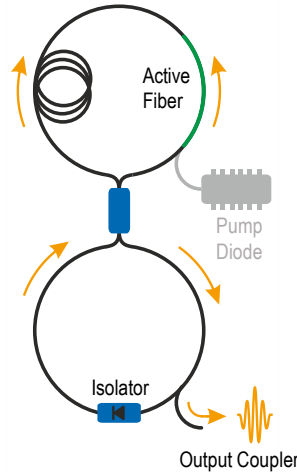

Figure 2. Figure-of-eight laser

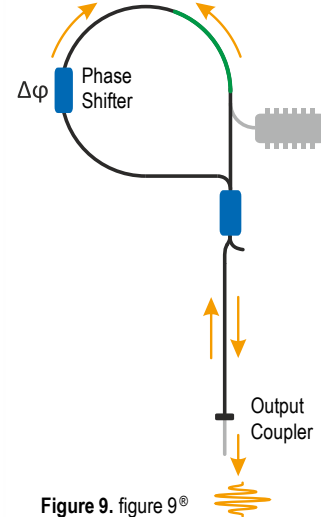

Figure 9. figure 9®

## FIGURE 9

figure 9® builds up on the NALM-based concept to advance its practicability and functional versatility to another level. The approach relies on operating the NALM in reflective mode, rather than in transmission, and allows the implementation of polarization-maintaining fiber components<sup>3</sup>.

As shown in Fig. 9, part of the cavity scheme is straightened into a linear arm, while a non-reciprocal phase shifter in the NALM part biases the phase acquired by counterpropagating pulse pairs. The amount of phase bias can thereby be carefully optimized for self-starting mode-locked operation at low intensities, as well as highly-efficient reflection into the linear arm under favorable operational conditions.

Thanks to its unique features, figure 9® has become the backbone of our femtosecond fiber laser portfolio, combining unprecedented performance with functional versatility:

- **Robust.**  
Robust self-start of mode-locked operation, in a layout offering the environmental insensitivity of polarization maintaining fibers.
- **Versatile.**  
Straight-forward integration of intracavity actuators for repetition rate tuning, synchronization, and carrier envelope phase (CEP) stabilization.
- **Low noise.**  
Exceptionally low intrinsic phase noise, surpassing the performance of fiber lasers mode locked by intrinsic saturable absorbers.
- **Cost-effective.**  
Excellent cost-performance ratio and low cost of ownership through reduced complexity, compactness, and use of standard telecom components.

<sup>3</sup> All Polarization-maintaining fiber laser architecture for robust femtosecond pulse generation, W. Hänsel et. al., Appl. Phys. B (2017) 123:41

# Put to the test

Quality: Made in Germany



## QUALITY STANDARDS

Our products are built in a controlled environment and pass rigorous final tests, both at component and system level, before leaving the factory. While we strive to select the best suppliers for highest quality, all of our products have fully traceable components. Our manufacturing is organized according to lean manufacturing standards. Processes are documented and operators undergo continuous training to ensure repeatability and reliability in operation. We make use of our in-house reference systems to qualify and calibrate our products against the best standards available.

Our processes and services are tested in accordance with DIN EN ISO 9001:2015 norm. As this requires a process-oriented quality management system, we have been testing and qualifying every single process at Menlo Systems to meet the highest quality standards. From order intake to the manufacturing process - all steps must go hand-in-hand to ensure the highest quality lasers “Made in Germany”.



## TESTING & CERTIFICATION

Besides meeting the conformity standards of the European Union, our femtosecond fiber lasers are tested and certified according to internationally recognized quality management standards:

Packaged Goods Vibration Test  
ISO 8318, IEC EN 600068-2-6

Packaged Goods Fall Test  
ISO 4180, IEC EN 600068-2-31

Sine Wave Vibration Test  
IEC EN 600068-2-6

Shock Test  
IEC EN 600068-2-17

EMC Test  
IEC EN 61326-1, Class a

# Beyond a supplier

A partner to pursue visions and ideas

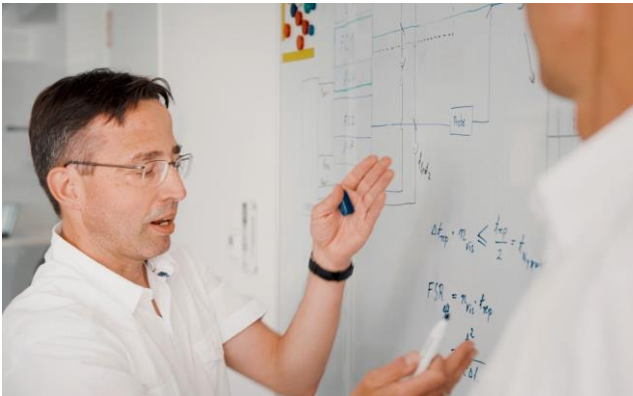

## APPLICATION-TAILORED SUPPORT

At Menlo Systems, we have grown a passionate team of product and application specialists: Our engineers truly understand the capabilities of our systems and have extensive knowledge of relevant applications. We make all efforts needed to define application-tailored solutions together with our customers - whether cutting-edge research labs, high-technology start-ups, or industry-leading OEM integrators.

While our femtosecond fiber lasers are all turn-key instruments that do not require any periodic maintenance or consumables, we remain a partner after system installation. Whenever needed, a skilled and resourced team will support upgrades, adaptations to evolving user requirements, or remote diagnoses and troubleshooting – with a 24-hour response philosophy to reduce any downtime. Via our subsidiaries in the USA, China, and Japan, we can guarantee this on-time support worldwide.

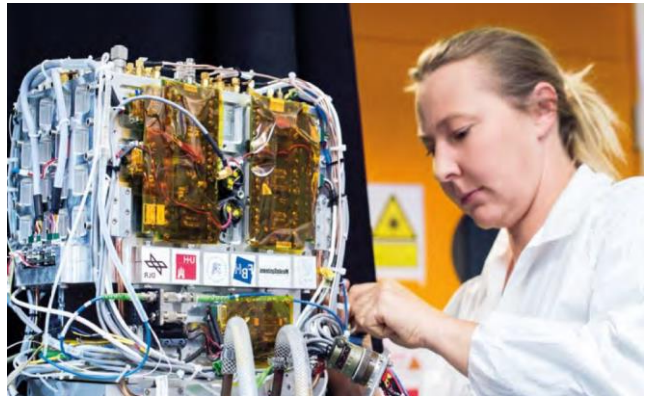

## INNOVATION IS AT OUR CORE

Tracing its origin to a spin-off from the renowned Max Planck Institute for Quantum Optics (MPQ) near Munich (Germany), Menlo Systems is close to 200-employees strong. Many of our team have had the privilege to work in some of the best laboratories around the globe before joining the company. It comes at no surprise that we maintain strong bonds to our scientific origins. Menlo Systems continuously strives to turn today's ideas into tomorrow's products through our leading Development & Custom Projects division, as well as together with research partners from all over the world.

Menlo Systems has been dedicated to serving the global photonics community from the very start. It is rewarding to see that our customer's trust and support has led to a continuous and organic growth of our product portfolio, our team, and the whole company. We continue to engage in trusting collaborations with our customers, while delivering products Made in Germany that meet growing demands with our established quality and performance - together we shape light!

Menlo Systems GmbH is a leading developer and global supplier of instrumentation for high-precision metrology. The company with headquarters in the west of Munich is known for its Nobel Prize winning optical frequency comb technology. With subsidiaries in the US, Japan, and China, and a global distributor network, Menlo Systems is closely connected to its customers from science and industry. The main product lines are optical frequency combs, time and frequency distribution, terahertz systems, ultrafast and ultra-stable lasers, and complete systems for quantum technology applications. Besides standard products, Menlo Systems develops and manufactures tailored solutions for laser-based precision measurements.



**Menlo Systems GmbH**

Bunsenstr. 5  
D-82152 Martinsried  
Germany  
T+49 89 189 166 0  
F+49 89 189 166 111  
[sales@menlosystems.com](mailto:sales@menlosystems.com)

**Menlo Systems US**

6205 Lookout Rd, Unit D,  
Boulder, CO 80301  
USA  
T+1 303 635 6406  
[ussales@menlosystems.com](mailto:ussales@menlosystems.com)

**Menlo Systems Japan**

12-5 Chuo Godo Building  
Chuo-2 Chuo-me  
Naka-ku Hamamatsu City 430 0929  
Japan  
T+81 907 409 2021  
[jpsales@menlosystems.com](mailto:jpsales@menlosystems.com)

**Menlo Systems China**

Room A502, No. 100 Lane 2891  
South Qilianshan Road Putou  
District Shanghai 200331  
China  
T+86 21 6071 1678  
[chinasales@menlosystems.com](mailto:chinasales@menlosystems.com)